



Redefining Supply



DELTA SAMA JAYA SDN. BHD. (DSSB)

(Company No. 500276-W)

(Registered with Ministry of Finance, Tenaga Nasional Berhad (TNB), CIDB, KTMB, Telekom (TM), etc.)

HIGH QUALITY CABLE SLAB / TILES **PLASTIC / CONCRETE**



No. 23G & 23M, DSSB Building, Jalan Perdana 6/8, Pandan Perdana,
55300 Kuala Lumpur, Malaysia
Tel: +603- 9282 4007, 03- 9281 3778 ; Fax: +603- 9287 0705

Website: www.substation.com.my

and

Website: www.cablecleat.com.my

E-mail: samajaya@substation.com.my (General)
E-mail: accounts@substation.com.my , sales@substation.com.my (Sales)



DELTA SAMA JAYA SDN. BHD. (DSSB) (Reg. No: 500276-W)

No. 23G & 23M, DSSB Building, Jalan Perdana 6/8, Pandan Perdana, 55300 Kuala Lumpur, Malaysia
Tel: +603-92824007, +603-92813778, Fax: +603-92870705
Email: (HQ): samajaya@substation.com.my, (Sales): sales@substation.com.my
(Accounts): accounts@substation.com.my
Website: www.cablecleat.com.my, www.substation.com.my
Installation and supplier for:-
Substation, Cabling, Earthing, Transformer, Cable Cleat, Power Plant, Steel Structure.
Registered with: Tenaga Nasional Berhad (TNB) and Ministry of Finance, CIDB, KTMB, Telekom, etc.

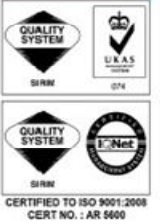

HIGH QUALITY PLASTIC CABLE SLABS / TILES (TRIPLE / SINGLE HOOK)

Introduction

Cable Slabs/Cover are used as visual warning indicators for cables laid underground, while at the same time provides mechanical protection for underground laid cables in the event of excavation work. The Cable Slab/Cover are buried below the ground level and above the underground cables.

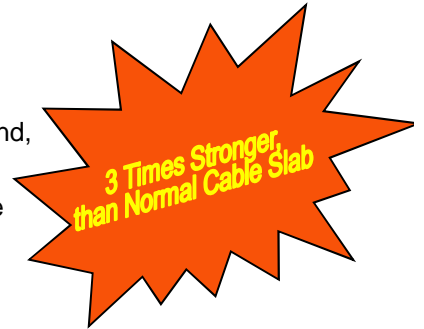

Advantages

- Very high impact strength properties to provides good mechanical protection for underground laid cables and pipes.
- Very lightweight- reduce risk of personal injury.
- Designed for easy transportation.
- Designed with interlocking end (hook and slot) to make simple and effective connection at site.
- Can be supplied in any colour and language, identifying the type of services buried below.
- Prevent or minimise damages to Electrical Cables, Telecommunication Cables, Signalling Cables, Fibre Optic Cables, Gas Pipes, Water Pipes, etc.
- High impact resistant
- Reduce the cost for repairing
- Accidental dropping does not damage cables
- No risk of accidental breakages
- Maintenance free
- Gives the clearest warning
- Enviromental Friendly

Marking and Embossing

The slabs shall be embossed with lettering to provide visual warning during excavation works and permanently marked as per customer's requirements.

Note:

Various feedback from sites and customers indicated that, conventional type single hook/slot interlocking slabs/covers easily disconnected/break from the next slab/cover due to only one single hook and slot system. Our Cable Slab is designed and improvised with 3 hooks/slots to withstand 3 times the pulling force and do not come off or break during excavation work or during installation.

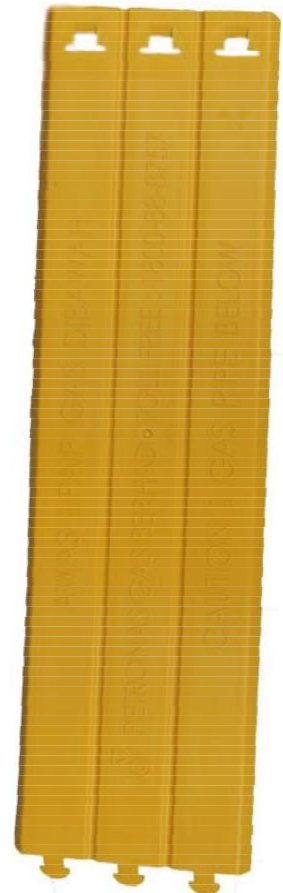

6mm thick
(triple hook)



Redefining Supply
An ISO 9001:2008
Company

DELTA SAMA JAYA SDN. BHD. (DSSB) (Reg. No: 500276-W)

No. 23G & 23M, DSSB Building, Jalan Perdana 6/8, Pandan Perdana, 55300 Kuala Lumpur, Malaysia
 Tel: +603-92824007, +603-92813778, Fax: +603-92870705
 Email: (HQ): samajaya@substation.com.my, (Sales): sales@substation.com.my
 (Accounts): accounts@substation.com.my
 Website: www.cablecleat.com.my, www.substation.com.my
 Installation and supplier for:-
 Substation, Cabling, Earthing, Transformer, Cable Cleat, Power Plant, Steel Structure.
 Registered with: Tenaga Nasional Berhad (TNB) and Ministry of Finance, CIDB, KTMB, Telekom, etc.



HIGH QUALITY PLASTIC CABLE SLABS/TILES (TRIPLE HOOKS)

(Thickness: 6mm)

Item Code	Size (mm)	Colour
DSSB-CSAP250Y-3-6	250mm(W) x 1000mm(L) x 6mm(T)	Yellow
DSSB-CSAP250O-3-6	250mm(W) x 1000mm(L) x 6mm(T)	Orange
DSSB-CSAP250G-3-6	250mm(W) x 1000mm(L) x 6mm(T)	Green
DSSB-CSAP250C-3-6	250mm(W) x 1000mm(L) x 6mm(T)	Customize



Laying of Protection Cover for gas pipe



Laying of fine Sand (covering the gas pipe)



Laying of Gas Pipe



Now you can customize
your own colour &
wordings!!!
Call: +603- 9282 4007



Redefining Supply
An ISO 9001:2008
Company

DELTA SAMA JAYA SDN. BHD. (DSSB) (Reg. No: 500276-W)

No. 23G & 23M, DSSB Building, Jalan Perdana 6/8, Pandan Perdana, 55300 Kuala Lumpur, Malaysia
Tel: +603-92824007, +603-92813778, Fax: +603-92870705
Email: (HQ): samajaya@substation.com.my, (Sales): sales@substation.com.my
(Accounts): accounts@substation.com.my

Website: www.cablecleat.com.my, www.substation.com.my

Installation and supplier for:-

Substation, Cabling, Earthing, Transformer, Cable Cleat, Power Plant, Steel Structure.

Registered with: Tenaga Nasional Berhad (TNB) and Ministry of Finance, CIDB, KTMB, Telekom, etc.

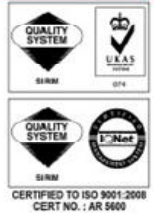

HIGH QUALITY PLASTIC CABLE SLABS/TILES (TRIPLE HOOKS)

(Thickness: 2mm)

Item Code	Size (mm)	Colour
DSSB-CSAP250O-3-2	250mm(W) x 1000mm(L) x 2mm(T)	Orange
DSSB-CSAP250G-3-2	250mm(W) x 1000mm(L) x 2mm(T)	Green
DSSB-CSAP250Y-3-2	250mm(W) x 1000mm(L) x 2mm(T)	Yellow
	Other size/colour please call for enquiry	



**Now you can customize
your own colour &
wordings!!!
Call: +603- 9282 4007**





DELTA SAMA JAYA SDN. BHD. (DSSB) (Reg. No: 500276-W)

No. 23G & 23M, DSSB Building, Jalan Perdana 6/8, Pandan Perdana, 55300 Kuala Lumpur, Malaysia
 Tel: +603-92824007, +603-92813778, Fax: +603-92870705
 Email: (HQ): samajaya@substation.com.my, (Sales): sales@substation.com.my
 (Accounts): accounts@substation.com.my
 Website: www.cablecleat.com.my, www.substation.com.my
 Installation and supplier for:-
 Substation, Cabling, Earthing, Transformer, Cable Cleat, Power Plant, Steel Structure.
 Registered with: Tenaga Nasional Berhad (TNB) and Ministry of Finance, CIDB, KTMB, Telekom, etc.



HIGH QUALITY PLASTIC CABLE SLABS/TILES (SINGLE HOOK)

(Thickness: 2mm)

Item Code	Size (mm)	Colour
DSSB-CSAP1000-1-2	100mm(W) x 1000mm(L) x 2mm(T)	Orange
DSSB-CSAP150R-1-2	150mm(W) x 1000mm(L) x 2mm(T)	Red
DSSB-CSAP200G-1-2	200mm(W) x 1000mm(L) x 2mm(T)	Green
DSSB-CSAP250Y-1GSM	250mm(W) x 1000mm(L) x 2mm(T)	Yellow
DSSB-CSAP250O-1-2	250mm(W) x 1000mm(L) x 2mm(T)	Orange
DSSB-CSAP250G-1-2	250mm(W) x 1000mm(L) x 2mm(T)	Green

Other size/colour please call for enquiry

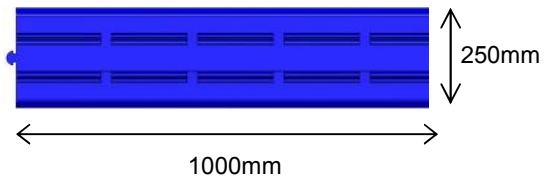
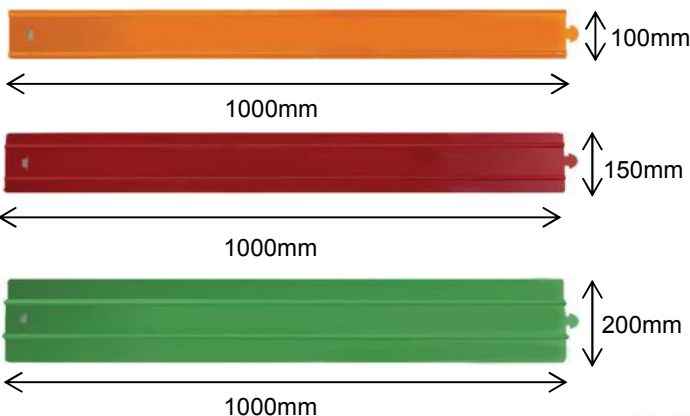
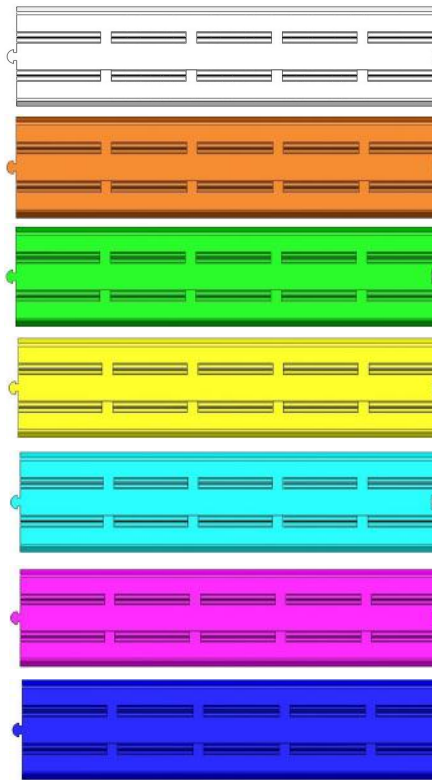

**Now you can customize
 your own colour &
 wordings!!!
 Call: +603- 9282 4007**





Redefining Supply
An ISO 9001:2008
Company

DELTA SAMA JAYA SDN. BHD. (DSSB) (Reg. No: 500276-W)

No. 23G & 23M, DSSB Building, Jalan Perdana 6/8, Pandan Perdana, 55300 Kuala Lumpur, Malaysia

Tel: +603-92824007, +603-92813778, Fax: +603-92870705

Email: (HQ): samajaya@substation.com.my, (Sales): sales@substation.com.my

(Accounts): accounts@substation.com.my

Website: www.cablecleat.com.my, www.substation.com.my

Installation and supplier for:-

Substation, Cabling, Earthing, Transformer, Cable Cleat, Power Plant, Steel Structure.

Registered with: Tenaga Nasional Berhad (TNB) and Ministry of Finance, CIDB, KTMB, Telekom, etc.

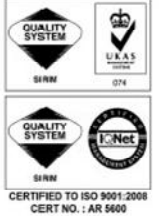

HIGH QUALITY CONCRETE CABLE SLAB / TILES (11kV, 33kV, 132kV and 275kV)

Item Code	Size	Weight (kg)
DSSB-CSM-CCS300C	300mm X 1000mm X 50mm	36
DSSB-CSM-CCS150C	150mm X 1000mm X 50mm	15
Wording : MERBAHAYA LETRIK		

***other wording are available upon request





DELTA SAMA JAYA SDN. BHD. (DSSB) (Reg. No: 500276-W)

No. 23G & 23M, DSSB Building, Jalan Perdana 6/8, Pandan Perdana, 55300 Kuala Lumpur, Malaysia
 Tel: +603-92824007, +603-92813778, Fax: +603-92870705
 Email: (HQ): samajaya@substation.com.my, (Sales): sales@substation.com.my
 (Accounts): accounts@substation.com.my
 Website: www.cablecleat.com.my, www.substation.com.my
 Installation and supplier for:-
 Substation, Cabling, Earthing, Transformer, Cable Cleat, Power Plant, Steel Structure.
 Registered with: Tenaga Nasional Berhad (TNB) and Ministry of Finance, CIDB, KTMB, Telekom, etc.

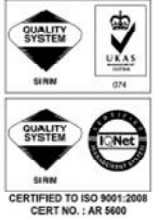

HIGH QUALITY CONCRETE CABLE MARKER (square)

Item Code	Size			Weight
	A (top)	B (height)	C (base)	
DSSB-CSM-CCMS300	TS125mm x	H300mm x	B175mm	15 kg
DSSB-CSM-CCMS400	TS100mm x	H400mm x	B150mm	18 kg

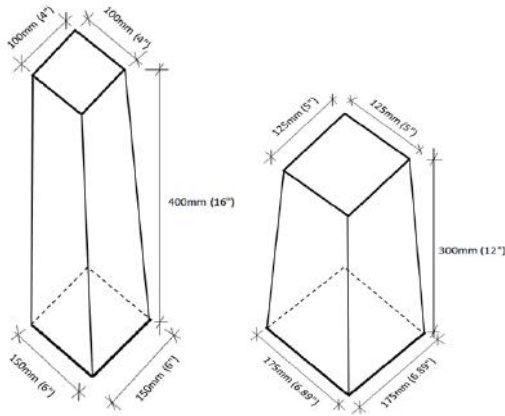

HIGH QUALITY CONCRETE CABLE MARKER (round)

Item Code	Size			Weight (kg)
	A (top)	B (height)	C (base)	
DSSB-CSM-CCMR375100	TS100mm x	H375mm x	B200mm	20 kg
DSSB-CSM-CCMR375150	TS150mm x	H375mm x	B225mm	20 kg

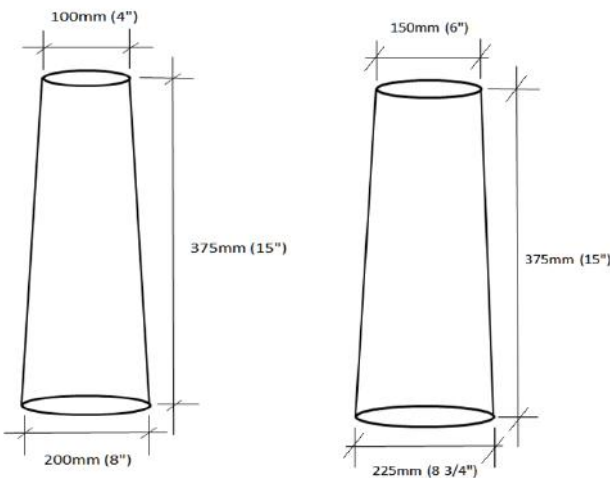



DELTA SAMA JAYA SDN. BHD. (DSSB) (Reg. No: 500276-W)

No. 23G & 23M, DSSB Building, Jalan Perdana 6/8, Pandan Perdana, 55300 Kuala Lumpur, Malaysia
 Tel: +603-92824007, +603-92813778, Fax: +603-92870705
 Email: (HQ): samajaya@substation.com.my, (Sales): sales@substation.com.my
 (Accounts): accounts@substation.com.my
 Website: www.cablecleat.com.my, www.substation.com.my
 Installation and supplier for:-
 Substation, Cabling, Earthing, Transformer, Cable Cleat, Power Plant, Steel Structure.
 Registered with: Tenaga Nasional Berhad (TNB) and Ministry of Finance, CIDB, KTMB, Telekom, etc.

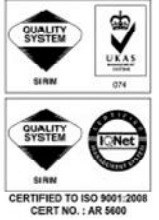

HIGH QUALITY CEMENT CABLE MARKER (round)

Item Code	Size			Weight (kg)
	A(top)	B (height)	C (base)	
DSSB-CSM-CCMR300	TS75mm x	H300mm x	B150mm	6

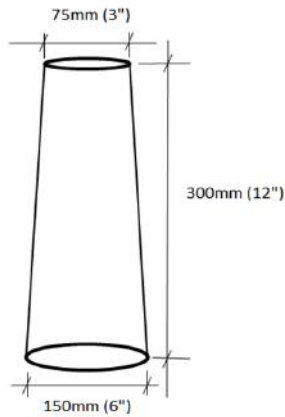

HIGH QUALITY CONCRETE JOINT MARKER

Item Code	Size			Weight (kg)
	A(top)	B (height)	C (base)	
DSSB-CSM-CJM781	TS194mm x	H781mm x	B375mm	32

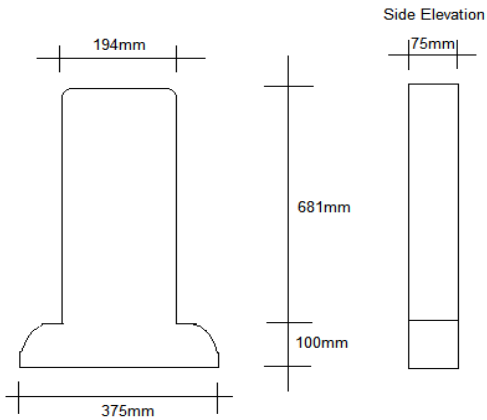

PHOTOS



HIGH QUALITY PLASTIC CABLE SLAB / TILES

• **CABLE SLABS OR TILES (ORANGE / GREEN COLOUR - 11 KV HIGH VOLTAGE POWER CABLES)
INSTALLED UNDERGROUND**

- 1) TO PROTECT OR SHIELD UNDERGROUND BURIED CABLES FROM DAMAGES DURING EXCAVATION/DIGGING WORKS.
- 2) TO PROVIDE VISUAL WARNING TO PERSON(S) DOING EXCAVATION WORK
- 3) TO DETER UNDERGROUND CABLE THEFT.
- 4) TO IDENTIFY TYPE OF CABLE(S) AND THE OWNERSHIP OF UNDERGROUND CABLE(S)





DELTA SAMA JAYA SDN. BHD. (DSSB) (Reg. No: 500276-W)

No. 23G & 23M, DSSB Building, Jalan Perdana 6/8, Pandan Perdana, 55300 Kuala Lumpur, Malaysia
Tel: +603-92824007, +603-92813778, Fax: +603-92870705

Email: (HQ): samajaya@substation.com.my, (Sales): sales@substation.com.my
(Accounts): accounts@substation.com.my

Website: www.cablecleat.com.my, www.substation.com.my

Installation and supplier for:-

Substation, Cabling, Earthing, Transformer, Cable Cleat, Power Plant, Steel Structure.

Registered with: Tenaga Nasional Berhad (TNB) and Ministry of Finance, CIDB, KTMB, Telekom, etc.

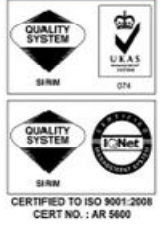

• CABLE SLABS OR TILES (ORANGE COLOUR – 11 KV HIGH VOLTAGE POWER CABLES) INSTALLED IN TOWN AREAS





DELTA SAMA JAYA SDN. BHD. (DSSB) (Reg. No: 500276-W)

No. 23G & 23M, DSSB Building, Jalan Perdana 6/8, Pandan Perdana, 55300 Kuala Lumpur, Malaysia

Tel: +603-92824007, +603-92813778, Fax: +603-92870705

Email: (HQ): samajaya@substation.com.my, (Sales): sales@substation.com.my

(Accounts): accounts@substation.com.my

Website: www.cablecleat.com.my, www.substation.com.my

Installation and supplier for:-

Substation, Cabling, Earthing, Transformer, Cable Cleat, Power Plant, Steel Structure.

Registered with: Tenaga Nasional Berhad (TNB) and Ministry of Finance, CIDB, KTMB, Telekom, etc.

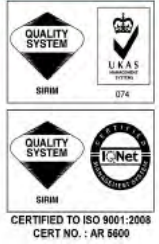

Reference List: High Quality Plastic Cable Slab / Tiles supplied / installed in various project for the last 5 years.

- 1 Petronas Bintulu, Sarawak
- 2 Kota Kinabalu, Sabah
- 3 ABB Algeria
- 4 TNB Cameron Highland, Pahang
- 5 SESB Sandakan, Sabah
- 6 Bentong Mini Hydro
- 7 TNB Pengkalan Industry, Perak
- 8 TNB Puchong Perdana 275kV Substation
- 9 TNB Shah Alam West 275kV Substation
- 10 TNB Ampang 275kV Substation
- 11 Malaysia Airport Berhad KLIA Project
- 12 Putrajaya Holdings Fibre Optic Cable Laying
- 13 Petronas, Kemaman
- 14 Petronas, Bintulu
- 15 P11, Putrajaya Holdings
- 16 PRASARANA Projek Mass Rapid Transit
Lembah Kelang Jajaran Sg. Buluh- Kajang Package
V2: Gas Malaysia Pipe Relocation Works
- 17 EPCC of the NG System for 100MW Combined Cycle
Power Plant in Kimanis, Sabah
- 18 EPCC of NGDS to Puchong Serdang (Looping)
FL Stage 1/12, Puchong, Selangor
- 19 Sabah Sarawak Gas Pipeline Project For Petronas Carigali Sdn Bhd
- 20 VTS Project
- 21 MES Project
- 22 Petronas, Negeri Sembilan
- 23 Petronas, Segamat
- 24 Petronas, Penang

Note : We have also been supplying to other companies,
which we do not have any records of their sites.

PHOTOS



HIGH QUALITY CONCRETE CABLE SLAB / TILES



DELTA SAMA JAYA SDN. BHD. (DSSB) (Reg. No: 500276-W)

No. 23G & 23M, DSSB Building, Jalan Perdana 6/8, Pandan Perdana, 55300 Kuala Lumpur, Malaysia
 Tel: +603-92824007, +603-92813778, Fax: +603-92870705
 Email: (HQ): samajaya@substation.com.my, (Sales): sales@substation.com.my
 (Accounts): accounts@substation.com.my
 Website: www.cablecleat.com.my, www.substation.com.my
 Installation and supplier for:-
 Substation, Cabling, Earthing, Transformer, Cable Cleat, Power Plant, Steel Structure.
 Registered with: Tenaga Nasional Berhad (TNB) and Ministry of Finance, CIDB, KTMB, Telekom, etc.

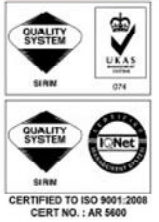

• CONCRETE CABLE SLAB / TILES INSTALLATION WORKS

- 1) Workers moving concrete cable slab / tiles into the location.
- 2) Ready for Installation.
- 3) Installation Complete.
- 4) Sand is used to cover the cable slab.





Redefining Supply
An ISO 9001:2008
Company

DELTA SAMA JAYA SDN. BHD. (DSSB) (Reg. No: 500276-W)

No. 23G & 23M, DSSB Building, Jalan Perdana 6/8, Pandan Perdana, 55300 Kuala Lumpur, Malaysia

Tel: +603-92824007, +603-92813778, Fax: +603-92870705

Email: (HQ): samajaya@substation.com.my, (Sales): sales@substation.com.my

(Accounts): accounts@substation.com.my

Website: www.cablecleat.com.my, www.substation.com.my

Installation and supplier for:-

Substation, Cabling, Earthing, Transformer, Cable Cleat, Power Plant, Steel Structure.

Registered with: Tenaga Nasional Berhad (TNB) and Ministry of Finance, CIDB, KTMB, Telekom, etc.

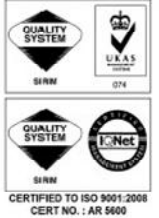

• CONCRETE CABLE SLAB / TILES INSTALLATION WORKS

Concrete Cable Slab / Tiles during relocation of underground power cables for MRT project in IKEA / One Utama Area.





DELTA SAMA JAYA SDN. BHD. (DSSB) (Reg. No: 500276-W)

No. 23G & 23M, DSSB Building, Jalan Perdana 6/8, Pandan Perdana, 55300 Kuala Lumpur, Malaysia

Tel: +603-92824007, +603-92813778, Fax: +603-92870705

Email: (HQ): samajaya@substation.com.my, (Sales): sales@substation.com.my

(Accounts): accounts@substation.com.my

Website: www.cablecleat.com.my, www.substation.com.my

Installation and supplier for:-

Substation, Cabling, Earthing, Transformer, Cable Cleat, Power Plant, Steel Structure.

Registered with: Tenaga Nasional Berhad (TNB) and Ministry of Finance, CIDB, KTMB, Telekom, etc.

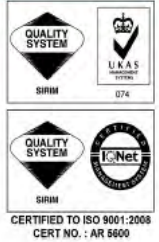

Reference List: Concrete Cable Slab supplied / installed in various project for the last 5 years.

- 1 TNB Section 18 275 / 132 kV Substation Shah Alam**
- 2 Solar Farm Project, Alor Star**
- 3 TNB Taman Jaya Substation**
- 4 MRT Line 1, Kota Damansara**
- 5 MRT Line 1, Relocation (One Utama)**
- 6 TNB Sg Abong 132kV Muar Substation**
- 7 TNB Ulu Terengganu 132 kV Substation**
- 8 Petronas Kemaman Project**
- 9 Jalan Pudu MRT Line 1 Project**
- 10. MRT Line 1 Lachau Project Sarawak**
- 11. MRT Line 1 Sungai Buloh Depoh**
- 12. MRT Line 1 Mutiara Damansara**

Note : We have also been supplying to other companies,
which we do not have any records of their sites.



Redefining Supply
An ISO 9001:2008
Company

DELTA SAMA JAYA SDN. BHD. (DSSB)

(Reg. No: 500276-W)

No. 23G & 23M, DSSB Building, Jalan Perdana 6/8, Pandan Perdana, 55300 Kuala Lumpur, Malaysia

Tel: +603-92824007, +603-92813778, Fax: +603-92870705

Email: (HQ): samajaya@substation.com.my, (Sales): sales@substation.com.my

(Accounts): accounts@substation.com.my

Website: www.cablecleat.com.my, www.substation.com.my

Installation and supplier for:-

Substation, Cabling, Earthing, Transformer, Cable Cleat, Power Plant, Steel Structure.

Registered with: Tenaga Nasional Berhad (TNB) and Ministry of Finance, CIDB, KTMB, Telekom, etc.

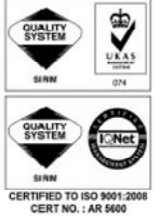

Drug No.: CSAP-250C-1 Rev No.:	If in doubt, Pls. Ask N.T.S.	<p>Note:</p> <p>Material : Plastic</p> <p>Dimension: 250mmx1000mmx2mm</p> <p>Code: DSSB-CSAP-250C-1</p>	For Approval Customer Chop & Sign
DISTRIBUTOR: DELTA SAMA JAYA SDN BHD 		Title: Telekom cable slab	DELTA SAMA JAYA SDN BHD (500276-W) No. 23G & 23M, DSSB Building, Jalan Perdana 6/8, Pandan Perdana, 55300 Kuala Lumpur. Tel. +603-92824007, 92813778 Fax. +603-92870705 Email: samajaya@substation.com.my Web: http://www.substation.com.my

NOTE: WE RESERVE THE RIGHTS IN THIS DOCUMENT AND IN THE INFORMATION CONTAINED THEREIN.
 REPRODUCTION, USE OR DISCLOSURE TO THIRD PARTIES WITHOUT DELTA SAMA JAYA SDN. BHD.
 EXPRESS AUTHORITY IS STRICTLY FORBIDDEN.

